

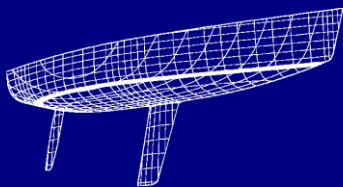

World Leader in Rating Technology

OFFSHORE RACING CONGRESS



International Measurement System
IMS 2022

Copyright © 2022 Offshore Racing Congress.

All rights reserved. Reproduction in whole or in part is only with the permission of the Offshore Racing Congress.

Cover picture: Inclining test measurement - Matteo Zuppini

Margin bars denote rule changes from 2021 version.



World leader in Rating Technology

INTERNATIONAL MEASUREMENT SYSTEM

IMS

2022

Offshore Racing Congress, Ltd.

www.orc.org

orc@orc.org

CONTENTS

Part A – ADMINISTRATION

A1	Language	3
A2	Abbreviations and Definitions	3
A3	Authorities	3
A4	WS Rules	3
A5	Rules Amendments	4
A6	Rules Interpretations	4
A7	Measurement	4

Part B – HULL

B1	General	5
B2	Measurement Procedure	5
B3	Hull Offset File	6
B4	Measurement Trim	6
B5	Flotation Measurements	8
B6	Additional Hull Measurements	8
B7	Other Hull Measurements	10

Part C – APPENDAGES

C1	Appednage definition	11
C2	Additional appendages measurements	11

Part D – PROPELLER

D1	General	13
D2	Propeller Types	13
D3	Propeller Installations	13
D4	Propeller Measurements	13

Part E – STABILITY

E1	General	16
E2	Inclining Test	16
E3	Canting Keel	17

Part F – RIG

F1	General	18
F2	Mainsail Hoist	18
F3	Mast Heights	18
F4	Mast Spar Dimensions	19
F5	Boom Spar Dimensions	19
F6	Rigging measurements	19
F7	Spinnaker Pole and Bowsprit	19
F8	Rig Weight and Centre of Gravity	20
F9	Other Rig Measurements	20
F10	Mizzen Rig Measurements	21

Part G – SAILS

G1	General	24
G2	Mainsail	24
G3	Mizzen	24
G4	Headsail	25
G5	Mizzen Staysail	25
G6	Spinnakers	25
G7	Quadrilateral sails and sails set on the wishbone boom	26
G8	Sail Measurement Stamp	26

APPENDIX 1 – CRUISER/RACER REGULATIONS

Part 1 – GENERAL

	Introduction	29
101	Cruiser/Racer Category	29
102	Fundamental Requirements and Definitions ...	29

Part 2 – ACCOMMODATION REQUIREMENTS

201	Accommodation Areas	30
202	Accommodation Length	30
203	Cabin Sole	30
204	Headrom	30
205	Living Area	30
206	Sleeping Area	30
207	Galey Area	30
208	Toilet & Wash Baisn	31
209	Navigation Area	31
210	Hanging Locker	31
211	Fresh Water Capacity	31
212	Fuel Capacity	31
213	Cockpit	31

	Index of Symbols	32
--	------------------------	----

Part A - ADMINISTRATION

A1 Language

- A1.1 The official language of the IMS is English and in case of dispute over translations the English text shall prevail.
- A1.2 The word "shall" is mandatory and the word "may" is permissive.

A2 Abbreviations and Definitions

- A2.1
- | | |
|-----|----------------------------------|
| IMS | International Measurement System |
| ORC | Offshore Racing Congress |
| WS | World Sailing |
| ERS | Equipment Rules of Sailing |
| RRS | Racing Rules of Sailing |

A2.2 Age Date

- a) Age Date shall be the month and year of the first launching when the boat was completed and equipped for sailing. Age Date may be taken either from the owner's documentary evidence or as month and date of the first measurement afloat.
- b) Age Date shall be changed and new measurement shall be required after any hull modifications except:
- change outside the canoe body, defined as the hull surface of the yacht, including transom, continued to the centerline tangentially from the point of final inflection into the keel and skeg
 - fairing of new appendages
 - removal of bumps outside the canoe body outer skin
 - filling of hollows (e.g., in the IOR after girth area)
 - forward or aft extensions or reductions of the fair surface of the hull, limited to modifications only within 0.10*LOA of the forward and/or aft end(s) of LOA

The total of modifications to the canoe body surface shall not exceed 20% of the total surface prior to modification.

- A2.3 **Series Date** shall be the Age Date of the earliest boat of an unmodified series built in the production moulds or jigs.
- A2.4 **Flotation Date** shall be the date when the most recent measurement afloat was completed.
- A2.5 **Measurement Date** shall be the date when the most recent measurement was completed.

A3 Authorities

The sole authority for the IMS is the Offshore Racing Congress and it shall be maintained and administered at the ORC's discretion.

A4 WS Rules

- A4.1 These **class rules** shall be read in conjunction with the ERS.
- A4.2 Except where used in headings, when a term is printed in "**bold**" the definition in the ERS applies and when a term is printed in "*italics*" the definition in the RRS applies.
- A4.3 When printed in "***bold italics***" the term is used as measurement taken or recorded by the measurer.

A5 Rules Amendments

Amendments to the ORC International are subject to the submission by the ORC Nominating bodies and approval of the ORC in accordance with the Articles of Association of ORC Ltd.

A6 Rules Interpretations

Any such interpretation shall be published and taken as rule change with immediate effect whenever needed. It may be overruled only by the ORC Management Committee and Congress, and if not objected it shall be included in the next rule revision with the necessary amendments.

A7 Measurement

- A7.1 The term “measurement” shall be taken to include also identification as to type, category, number, material, construction, etc. as may be determined by examination or declaration.
- A7.2 Measurements shall be taken from the yacht wherever practicable but where this is unduly difficult the Chief Measurer may approve the use of plans or other such sources of information as he considers reliable.
- A7.3 Measurers shall be appointed by the ORC or, with the approval of the ORC, by the Rating Authority. A Measurer shall not measure a yacht of another Rating Authority without the permission of that Authority. No Measurer, assistant, nor Rating Office staff shall participate in the measurement or processing of measurements of a yacht owned, designed or built, wholly or partly, by himself or in which he is an interested party, or in which he has acted as a consultant or has a vested interest. Except for reasonable and brief clarification of points in the Rules, this applies to any consultation or advice on rating values regardless of whether or not any payment is involved.
- A7.4 Measurements, unless otherwise specified, shall be taken and recorded to the nearest greater value as follows:
- a) **Metric system:** All measurements shall be in meters to three decimal places except that sail measurements shall be to two places of decimals. Weights shall be in kilograms to one decimal place.
 - b) **Imperial system:** All measurements shall be in feet to two decimal places except that sail measurements shall be to one decimal place. Weights shall be in pounds.
- A7.5 In case of doubt in any measurement taken or recorded or any procedure, the measurer shall refer his questions, together with the relevant facts, to the ORC Chief Measurer and shall be bound by his interpretation.

Part B - HULL

B1 General

- B1.1 Monohulls and multihulls may be measured. However, for the monohulls, except at the recess in the area where appendages connect to the hull, the canoe body depth in any section shall not decrease towards the center line.
- B1.2 A hull measurement shall be performed to create an OFF file describing the body plan of the hull together with appendages by using an ORC approved hull measurement machine or any available measurement instrument capable to measure points in the co-ordinate system as defined herein and detailed in the "ORC OFF File Format" document.
- B1.3 The coordinates system defining the hull shall be positioned as follows:
- X axis – longitudinal with 0 at stem and positive towards the stern
 - Y axis – transverse with 0 at the centerline and positive outwards
 - Z axis – vertical with 0 at the waterline and positive upwards

B2 Measurement Procedure

- B2.1 The yacht shall be presented for measurement ashore in an accessible location, clear of obstructions, properly and firmly chocked and leveled athwartships and approximately in the same longitudinal trim which it might reasonably be expected to assume when afloat in measurement trim. A centerboard, if any, shall be in its maximum raised position. A centerboard that can be locked to prevent movement while *racing*, shall be in its locked position and measured as a keel. Rigging shall be slack. All appendages shall be fitted and any fairings shall be in place.
- B2.2 Station points shall be taken starting from lowest point at the centerline following the shape of the station as follows:
- A minimum of 20 stations and a maximum of 180 shall be taken from each side spaced with a maximum distance of 5% *LOA*. Within the forward and aft 15% of *LOA* the spacing between stations shall not be greater than 2.5% of *LOA*.
 - The forward freeboard station shall normally be placed approximately 0.5 m from the stem, but it may also be placed in other easily recognized distance from the stem (bobstay fitting).
 - The aft freeboard station shall normally be placed at the aftermost section at which the hull could be girthed without crossing the transom, but it may also be placed in other easily recognized distance from the stem (for example transom end).
 - Stations shall be taken also at the edges of any appendage, at the maximum draft and at any significant change of profile in longitudinal direction.
 - Freeboards stations and at least one midship section shall be taken from both sides at the same distance from the bow.
- B2.3 The top point at any measurement station shall normally be the lowest point on the topsides of the hull where a tangent at 45 degrees can be rested on the hull. Where any bulwark is a fair continuation of the line of the topsides of the yacht, the top point shall be taken on the top of the bulwark. A bulwark shall be interpreted to mean any part of the topsides extending above the lowest level of the deck at that station.
- B2.4 The freeboard points shall be taken on the freeboard stations as either of:
- The top point as defined in B2.3; or
 - Any other point that can be clearly identified on the hull and if needed described with photo or drawing

Various top points

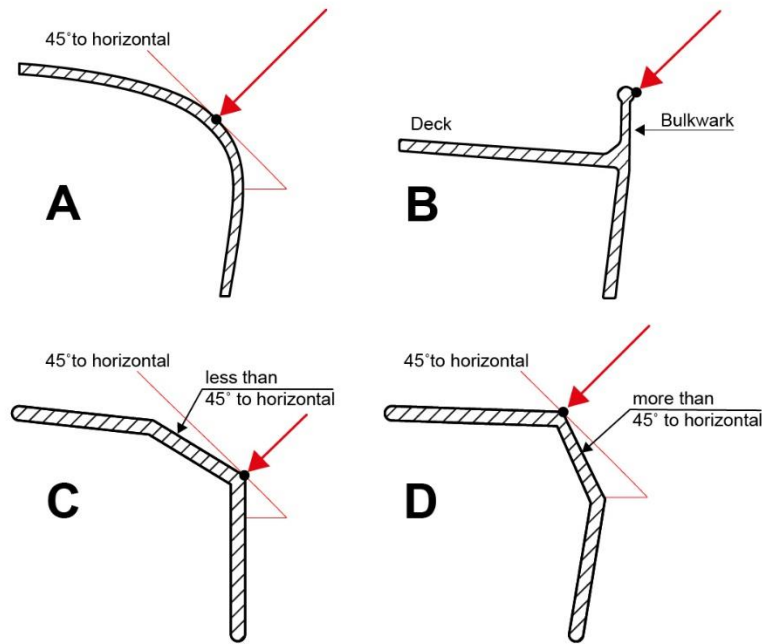

B3 Hull Offset File

- B3.1 Once a hull is completely measured, an OFF file shall be generated using ORC-approved software by the Rating Authority or if needed by the ORC Chief Measurer. The OFF file shall be accompanied with relevant documentation such as photos of freeboard points or diagrams describing complete hull, appendages or other details. Where a number of hulls of the same model are built using the same moulds for the hull, keel and rudder, a standard OFF file for that model will be created and no hull measurement will be needed for other boats built from the same mould.
- B3.2 Any change of the hull, keel or rudder of a model with an existing OFF file shall be re-measured again and a new OFF file shall be created. In case of minor changes new measurements may be taken directly on the changed parts by taking new dimensions comparing existing point coordinates and changing them to the new values. Any larger changes shall be re-measured using the same method as on the original model.

B4 Measurement Trim

- B4.1 Boats shall be dry in light ship condition without crew and shall include the following:
- a) Internal ballast, if any, which shall be fixed below the cabin sole, or as low as possible at any station and fixed to the hull structure to prevent movement.
 - b) Batteries.
 - c) Fixed and/or essentially permanent interior accommodation, hatch covers and floor boards.
 - d) Fixed and/or essentially permanent machinery, electrical and plumbing systems.
 - e) Outboard engine in the position as carried on board while racing, properly secured on its bracket, or stowed on board, with its center of gravity abaft the mast.
 - f) Mast, boom, spinnaker pole and/or sprit, if any, in their normal position when racing upwind. Masts shall be raked aft to the limit of their adjustment. Where this limit is forward of the vertical the mast shall be set vertical.

- g) Standing rigging and fittings. All standing rigging and related fittings used whilst *racing* shall be attached in their normal positions. Running rigging forward of the mast and all halyards and lifts shall be taken to the foot of the mast and hauled tight. All other pieces of running rigging abaft the mast shall be taken to their aftermost position and hauled tight. All halyard tails shall be taken to their normal working positions. If the halyard weight varies significantly along its length, the tail shall be on the cabin floor for the inclining experiment, with the halyard fully hoisted and attached to a light messenger line. A halyard may be used as a topping lift.
- h) Rudder, wheel/tiller and steering gear, fitted complete as for racing.
- i) Keel and any bulb, fitted complete as for racing.
- j) Centerboard(s) and drop keels shall be fully raised. If any drop keel or movable appendage is to be locked when *racing* it shall be so locked and the locking device shall be in place.
- k) All fixed electronics, instruments, compasses, lights, antennas and masthead devices.
- l) All halyards as for racing.
- m) Boom running rigging and any vang, as for racing. Booms shall be secured at the low points of *P* and *PY*, as the case may be.
- n) Hydraulic systems including hydraulic tanks shall be full for measurement and shall remain full when *racing*.
- o) Pulpits, stanchions and lifelines.
- p) Mattresses and permanently installed table, doors on their normal position.
- q) Permanently installed stoves, heaters or other electrical devices.
- r) DSS appendage shall be completely retracted with no part outside of the hull.
- s) Bilgeboard(s) shall be fully raised.

B4.2 Specifically excluded from Measurement Trim are the following:

- a) Water and the liquid contents of any tanks or voids in the keel or any other appendage. Fuel tank shall be as empty as possible (recommended). If this is not possible, the tank's capacity, distance from stem and condition at measurement shall be recorded. Multiple fuel tanks shall not be connected during measurement unless they are empty.
- b) Any ballast not included in B4.1, except any corrector weight required by the relevant One Design Class Rule to which the boat complies.
- c) Any sails, including storm and emergency sails.
- d) Sheets, blocks, winch handles and other running rigging, except as in B4.1 above.
- e) All portable safety gear, including fire extinguishers and liferafts.
- f) Cushions, pillows and any other bedding, towels, etc.
- g) All cooking and eating utensils, portable heaters and compressed gas bottles
- h) Any food or stores
- i) All tools, spares and stores.
- j) Miscellaneous portable and personal gear, books, navigation tools, etc.
- k) Anchors and anchor ropes, including both chain and fiber.
- l) Dock and mooring lines and any other cordage.
- m) Outboard engine when it is not carried on board while racing.

B4.3 For boats with *LOA* > 24.0 m items listed in B4.2 when impracticable to be removed from the boat, may remain aboard with their weight and longitudinal and vertical position recorded. Freeboards and stability measurements shall then be adjusted by subtracting recorded items. This procedure shall be verified and approved by the ORC Chief Measurer.

B4.4 Measurement inventory shall be recorded as follows:

a) **Ballast**

- i) Fixed ballast: description, weight, distance from stem, height from the waterline
- ii) Movable ballast: **WBV** shall be recorded as the maximum water ballast volume in litres (gallons in imperial units) that can be loaded on one side with its longitudinal distance from stem, vertical distance from the waterline and transversal distance from the boat's centreline.

b) **Tanks**: use, description, capacity, condition at measurement, distance from stem, height from the waterline,

c) **Other items**: description, weight, distance from stem, height from the waterline shall be recorded for:

- i) Permanently installed items such as: battery, engine, water heater, air conditioner and similar
- ii) For boats measured before 01/01/2013 and boats with **LOA** > 24.0 m when B4.3 is applied; anchor, anchor chain, tools, safety equipment, deck gear

B5 Flotation Measurements

B5.1 **SFFP** shall be the horizontal distance from the forward end of LOA to the forward freeboard station.

B5.2 **SAFP** shall be the horizontal distance from the forward end of LOA to the aft freeboard station.

B5.3 **FFM** shall be the average of port and starboard freeboards measured vertically from the water level to a freeboard point at the station at **SFFP** from stem within the OFF file.

B5.4 **FAM** shall be the average of port and starboard freeboards measured vertically from from the water level to a freeboard point at the station at **SAFP** from stem within the OFF file.

B5.5 **SG** shall be the specific gravity of the water sampled from a level 0.3 m below the surface.

B6 Additional Hull Measurements

B6.1 Hull measurements defined below in rule B6 can be calculated from the OFF file with flotation measurement or obtained from direct measurement.

B6.2 **LOA** shall be the length overall of a yacht including the whole hull, excluding any spars or projections fixed to the hull such as chainplates, bowsprits, boomkins, pulpits, etc., and as measured between

- a) a point forward being the forwardmost of the following points:
 - i) the stem of the yacht, whether carried above the deck level or not, or
 - ii) the bulwarks of the yacht where these are extended above the stem.
- b) a point aft, being the extreme after end of the hull and bulwarks or taffrail of the yacht whether at, above, or below deck level. Rubbing strakes at the stern will be included. If a rudder and/or a push-pit extend abaft this point, neither one nor the other will be included.

B6.3 **MB** shall be the maximum beam.

B6.4 **SMB** shall be the horizontal distance from the forward end of LOA to the maximum beam station.

B6.5 **SDM** shall be the distance from the bow to the maximum draft section.

B6.6 **DMT** shall be the vertical distance from the deepest point of keel (including any bulb) to the top point at the same section.

B6.7 **FDM** shall be the average of port and starboard freeboards measured vertically from the the water level to the top point at the section at **SDM** from stem.

B6.8 **FBI** shall be the average of port and starboard freeboards measured vertically from the the water level to the top point at the section at the fore side of the mast.

B6.9 **Y** shall be the freeboard measured vertically from the aftermost point of the hull to the water level at the boat's centerline.

B6.10 **FO** shall be the forward overhang measured as follows:

- a) If the bow knuckle is above the waterline, **FO** shall be the horizontal distance from the forward end of **LOA** to the point where a 45 degree angle intersects the knuckle.
- b) If the bow knuckle is below the waterline, **FO** equals the horizontal distance from the forward end of **LOA** to the intersection of the stem with the waterline.

B6.11 **DSPW** shall be the total weight of a boat in measurement trim.

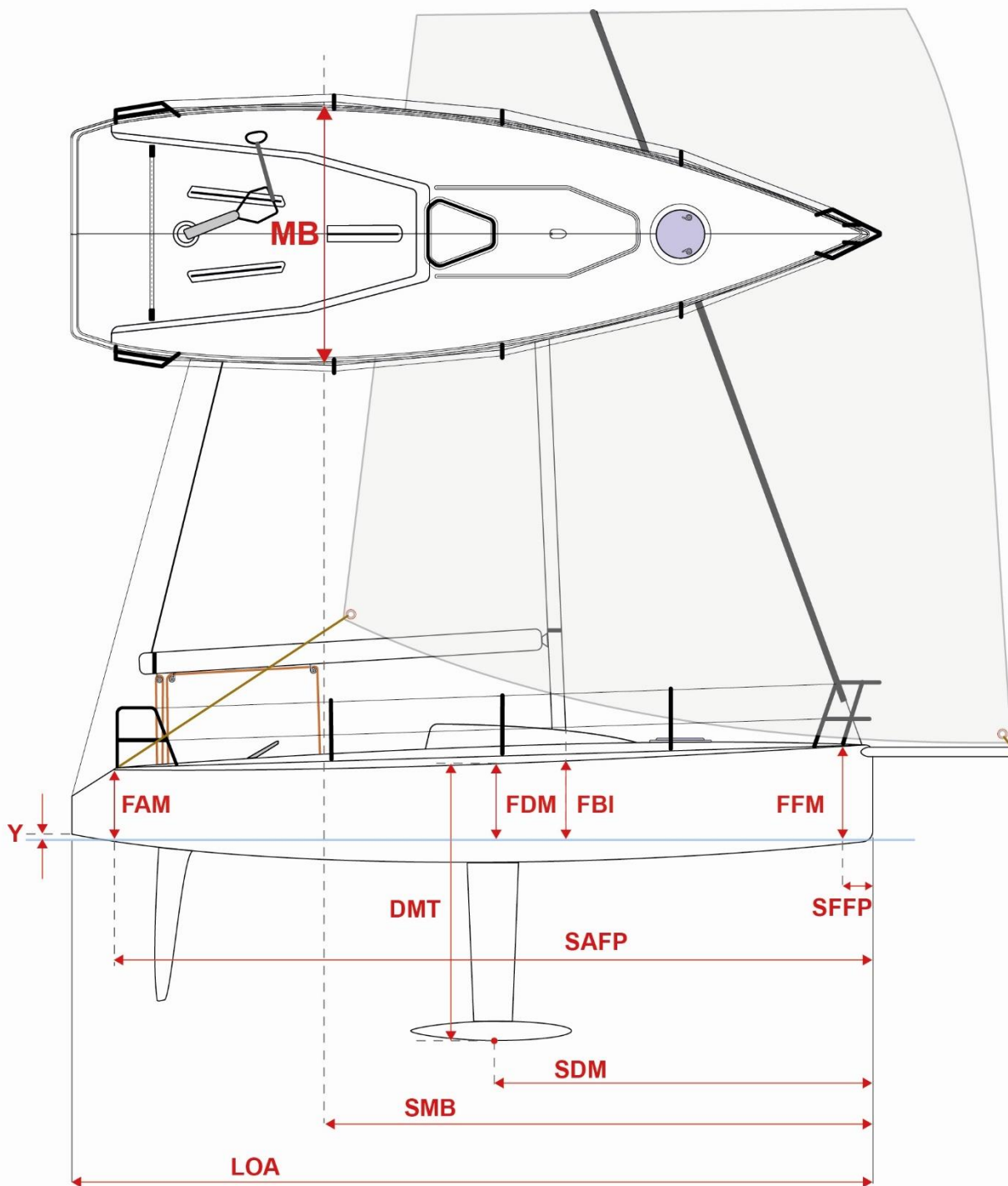

Diagram for illustration only

B7 Other Hull Measurements

B7.1 **Hull construction** shall be recorded as one of the following:

- a) **SOLID**: Non-cored, solid E-glass, metal or wood hull and deck, but including also E-glass decks with core material. Where the construction is of wood, the minimum density of any layer shall not be less than 300 kg/m³.
- b) **CORED**: Hull skin of E-glass (see above) or wood, but incorporating a core material of less density than the skin.
- c) **LIGHT**: All other construction types, but excluding the incorporation of any carbon fiber.
- d) **CARBON**: Where carbon fiber has been incorporated anywhere in the construction of the hull shell and/or deck shells.

Carbon fiber edge-capping of bona fide hull structural frames, girders and stringers, and as localized reinforcement of chain plate attachments is allowed in each hull construction category provided it is used below decks between $0.3 * LOA$ and $0.7 * LOA$ aft of the stem.

For hull and deck construction, a declaration from the owner may be substituted for examination of one or more elements, but all elements are subject to examination at any time in case of doubt.

For the purposes of this rule, *hull and deck shell* are considered as the envelope surfaces of the hull and deck that impart shape, excluding attached structural frames, floors, bulkheads, girders and stringers, and localized reinforcements such as chain plate attachments.

B7.2 **Honeycomb core** In addition to recording the appropriate construction type as above, if a honeycomb core has been incorporated in hull or deck construction, this shall also be recorded as "YES" and if not as "NO".

B7.3 **Rudder construction** shall be classified as one of the following:

- a) **STANDARD**: Rudder stock does not contain any carbon fiber.
- b) **CARBON**: Rudder stock contains carbon fiber in any amount.

B7.4 **Forward Accommodation** When the interior volume forward of the mast is fully fitted out as a separate sleeping or living area (toilet and wash basin do not qualify) built of solid construction, including berths (pipe berths do not qualify) with mattresses and cushions on settees, personal gear stowage, etc. complying with Cruiser/Racer Regulations (Appendix 1) this shall be recorded as "YES" and if not as "NO".

B7.5 **Light materials in lifeline elements** If there is light material such as titanium or carbon used in lifelines elements (stanchions, pulpits, pushpits etc.) this shall be recorded as "YES" and if not as "NO".

Part C - APPENDAGES

C1 Appendage definition

Hull offset files shall include a fixed keel and single rudder set below the hull. Any other appendage such as a centerboard, transom hung rudder, twin rudders, bilgeboards, DSS, or foils shall be defined as follows:

Appendage should be set up in the local coordinating system with X axis – longitudinal, Y axis – transverse and Z axis.

In such a defined coordinating system, a series of points with its x, y and z coordinates describing the 'rondure' of the appendage shall be defined together with the associated chord and thickness at each point.

Two anchor points defined with x, y and z coordinates in a respective coordinating system for each set of hull and appendages shall be defined so that it will position the appendage in relation to the hull offset file. Additionally, two rotation angles around x and y coordinates shall be defined to align the local appendage coordinating system with the global hull offset file coordinating system.

All appendages shall then be recorded as additional parts of the hull offset file.

#	X	Y	Z	Chord	Thickness
1	0	0	0	512	59
2	38	0	-241	440	55
3	79	0	-669	360	48
4	118	0	-957	311	42
5	147	0	-1087	280	36
6	161	0	-1121	265	33
7	184	0	-1149	240	29
8	238	0	-1165	190	5

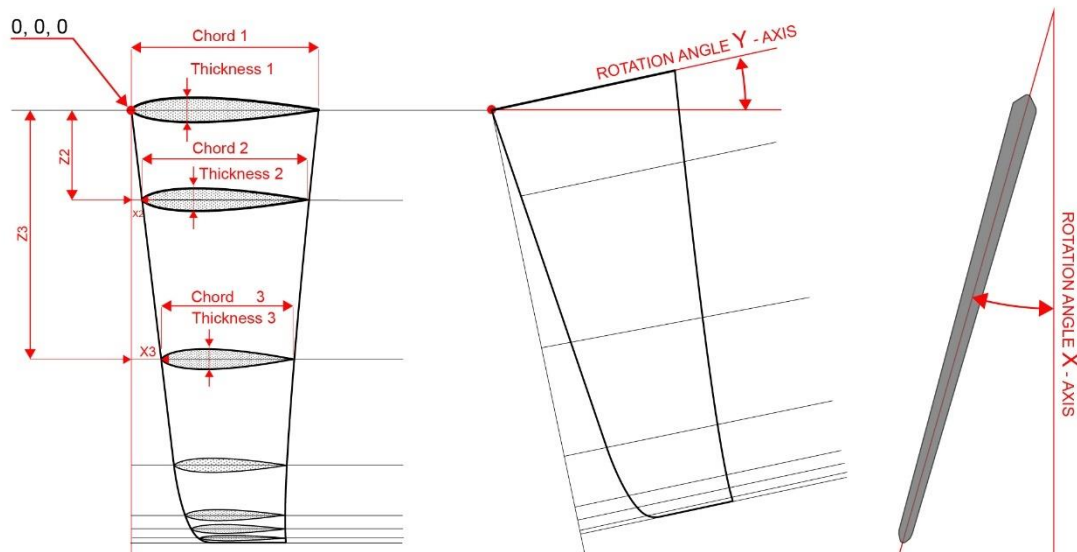

Diagram for illustration only

C2 Additional appendages measurements

- C2.1 **WCBA** shall be the weight of the centerboard or drop keel. Where there is more than one board the weight of the additional board shall be recorded as **WCBB**.
- C2.2 For each retractable appendage the percentage of the span remaining outside of the hull when the appendage is fully raised shall be recorded with 1.0 meaning that the appendage remains fully extended.
- C2.3 For each appendage rotating about single transverse axis a maximum angle of rotation shall be recorded.
- C2.4 The presence of a movable trim tab shall be recorded.

Part D - PROPELLER

D1 General

- D1.1 Speed under power with propeller in smooth water and without assistance of wind shall not be less than $1.811 * LOA^{0.5}$ (knots) where LOA is in meters ($LOA^{0.5}$ where LOA is in feet).
- D1.2 The propeller shall at all times be ready for use and shall not be retracted, housed or shielded except by a conventional strut or aperture.
- D1.3 The propeller shaft exposed to water flow shall be circular in cross section.
- D1.4 If any of the requirements from D1.1, D1.2 or D1.3 are not met, this shall be recorded as "NO PROPELLER".
- D1.5 The presence of permanently deployed hydro-generator shall be recorded with "YES" or "NO".

D2 Propeller Types

- D2.1 **Solid Propeller** shall be a standard model in series production, unaltered, having a minimum of two fixed blades of normal elliptical shape and a maximum width of not less than $0.25 * PRD$ measured across the driving face of the blade on a chord at right angles to the radius of the blade. Pitch shall not be greater than the propeller diameter. Hub and blade area projected into a plane at right angles to the shaft line shall not be less than $0.2 * PRD^2$.
- D2.2 **Folding Propeller** shall be a standard model in series production, unaltered, having a minimum of two blades that fold together pivoting on an axis at right angles to the shaft line when not being used for propulsion or any other propeller not qualifying as a solid propeller.
- D2.3 **Feathering Propeller** shall be a standard model in series production, unaltered, having a minimum of two blades that pivot so as to substantially increase pitch when not being used for propulsion.

D3 Propeller Installations

- D3.1 **In Aperture** installation shall be with solid propeller entirely surrounded in the vertical plane of the shaft line by the keel, skeg, and/or rudder.
- D3.2 **Strut Drive**. The drive train shall be enclosed in a strut and the unit incorporating drive train and strut shall be of a standard model in series production. The surface and shape of the unit may be faired (e.g., with fillers) provided that its function is in no way impaired and none of the dimensions required for measurement of the unit are reduced relative to those as manufactured. For qualified units, where ORC standard dimensions are provided, they shall be used in place of measurements.
- D3.3 **Shaft not exposed** installation shall be in the form of a moulded housing with the strut integrated with the hull and included in the hull offset file, enclosing most of the length of the shaft as well as the void between the shaft and the hull.
- D3.4 **Shaft exposed**. All other types of propeller installation with a shaft

D4 Propeller Measurements

- D4.1 **PRD** shall be the diameter of the propeller disc.
- D4.2 **PHD** shall be the smallest dimension through the shaft centerline of the projected area of the propeller hub.
- D4.3 **PHL** shall be the distance from the shaft end of the propeller hub to the intersection of the blade axis and shaft.
- D4.4 **PBW** shall be the propeller blade width measured across the driving face of the blade on a chord at right angles to the radius of the blade.

- D4.5 **PSA** shall be the angle between the centerline of the propeller shaft and a tangent to a hull buttock line 0.15 m (0.5 ft) off the hull centerline midway between the axis of the propeller blades and the point where the propeller shaft emerges from the hull. This angle approximates the angle between the propeller installation's shaft axis and the water flow past it. Any unfairness or reverse inflection shall be bridged to yield a fair approximation of the slope of the hull body in way of the propeller shaft. If the propeller shaft is not on the centerline, **PSA** shall be measured on the plane defined by the propeller shaft and the strut.
- D4.6 **PSD** shall be the minimum propeller shaft diameter exposed to water flow including that part of the shaft within the strut hub.
- D4.7 **ESL** shall be the length of the exposed shaft measured from the center of the propeller (the intersection of the blade axis and shaft) to the point at which the shaft center line emerges from the hull or appendage. For a boat with a Series Dates 1/1985 or later, **ESL** shall be the lesser of **ESL** as defined above or the length of the line $8.0 * PSD$ below the shaft axis and parallel to it measured from the blade axis to the fair line of the aft edge of the keel.
- D4.8 **EDL** shall be the distance, measured along and in prolongation of the propeller shaft, from the center of the propeller to the aft edge of any other strut or fin (except the rudder blade) forward of the propeller.
- D4.9 **ST1** shall be the minimum projected thickness of the strut at any point between the hull and the shaft.
- D4.10 **ST2** shall be the minimum width of the strut, (including the strut hub) measured parallel to the shaft.
- D4.11 **ST3** shall be the maximum width of the strut, measured parallel to the shaft, not above a line $0.3 * PRD$ above the shaft centerline.
- D4.12 **ST4** shall be the smallest dimension through the shaft centerline of the projected area of the strut hub within **ST2** of the aft end of the strut hub.
- D4.13 **ST5** shall be the distance, measured perpendicular to the propeller shaft at the forward end of **ST2**, from the centerline of the shaft to the hull or fair continuation of the hull.
- D4.14 If any of **ST1 – ST4** measurements for the strut drive installation has been increased by the fairing of the standard production unit, **ST1 – ST4** shall be recorded as manufactured.
- D4.15 **APH** shall be the maximum height of the aperture opening measured at right angles to the shaft line.
- D4.16 **APT** and **APB** shall be the maximum widths of the aperture opening measured parallel to the shaft line at distances not less than $PRD / 3.0$ above and below the shaft line.
- D4.17 For each of the propeller installation types, the following measurements shall be taken:
- a) In Aperture: **PRD, APH, APT, APB**
 - b) Strut Drive: **PRD, EDL, ST1, ST2, ST3, ST4, ST5**
 - c) Shaft not exposed: **PRD, PHD, PHL, PSA, PSD, ESL**
 - d) Shaft exposed: **PRD, PHD, PHL, PSA, PSD, ESL, ST1, ST2, ST3, ST4, ST5**
- D4.18 The presence of twin propellers shall be recorded with “YES” or “NO”.

In Aperture

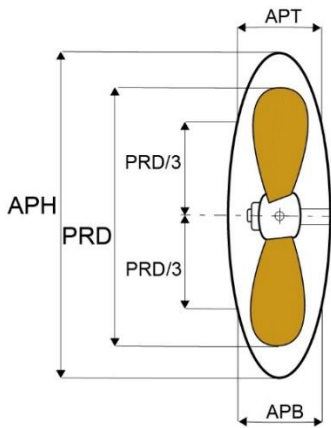

Strut Drive

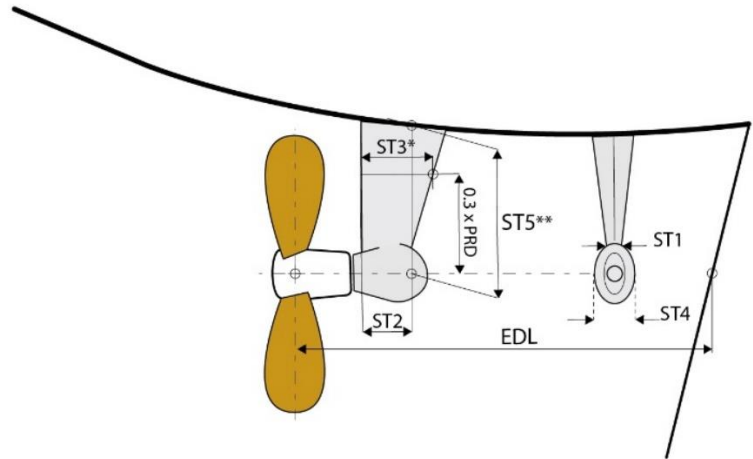

Shaft not exposed

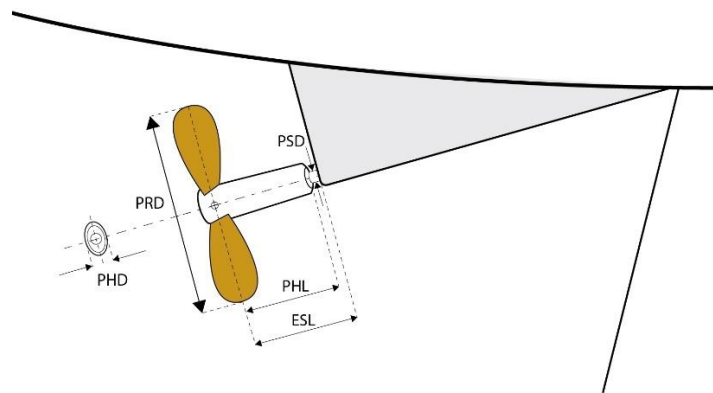

Shaft exposed

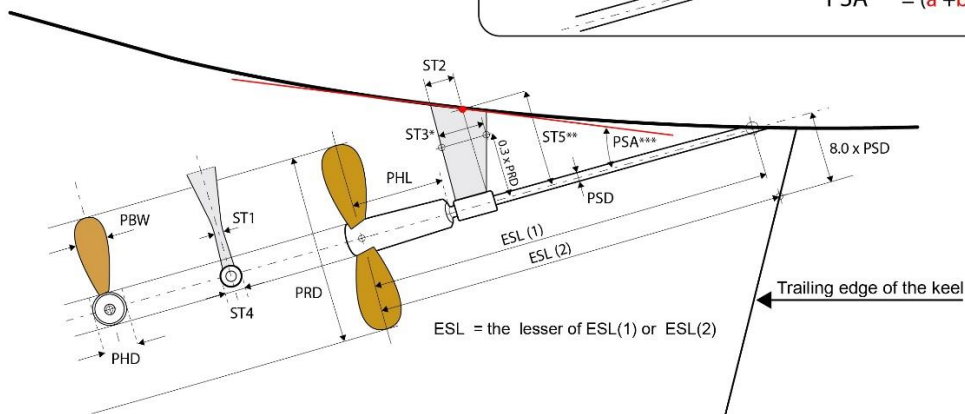
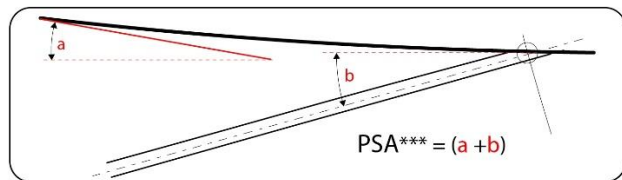

- *ST3 is the maximum strut width measured parallel to the propeller shaft found not more than 0.3 x PRD.
- **ST5 is measured perpendicular to the shaft centerline from the hull to the shaft centerline at the forward end of ST2.
- ***PSA (Propeller Shaft Angle) may be measured in two steps:
 1. Angle between shaft centerline and level datum line.
 2. Angle between buttock tangent line and level datum line.
 Add angles to arrive at PSA.

Diagram for illustration only

Part E - STABILITY

E1 General

- E1.1 Inclining test measurements shall be performed in calm water with the boat not depressed on any side by lying to a mooring, and with no one aboard while in measurement trim.
- E1.2 A manometer as a "water scale" or an ORC-approved electronic inclinometer shall be used.

E2 Inclining Test

- E2.1 The inclining test shall be performed as follows:
- a) The boat shall be in measurement trim as defined in B4.
 - b) Two poles shall simultaneously be positioned port and starboard, approximately at the LCF (longitudinal centre of flotation). The poles shall be suspended outboard to provide arms for supporting inclining weights, and arranged to be normal to the boat's centerline and as horizontal as possible but allowing sufficient clearance to prevent the weights from touching the water. The poles shall be approximately *SPL* in length and the yacht's pole or poles shall be used when available. If a yacht's pole is not used for the inclining test it shall not be on board.
 - c) Either a manometer or an ORC-approved electronic inclinometer shall be placed on the deck and positioned athwart the yacht where it can be read by the measurer.
 - d) When the poles are rigged and all the weights suspended on the starboard side the datum on the manometer shall be marked. Where an electronic inclinometer is used, the datum position may be recorded four times in succession.
 - e) If the manometer is used the weights shall be transferred one by one to the port side, weight transferred and manometer reading shall be recorded. As an alternative or when an electronic inclinometer is used, all weights may be transferred at once to the port side, and the resulting angle recorded four times in succession.
 - f) All the weights shall be suspended on the starboard side once again and the datum on the manometer verified.
- E2.2 Alternative to the procedure defined in E2.1 and particularly on boats that would require heavier weights to be suspended, a boat's boom may be used to suspend weights as follows:
- a) The boat shall be in measurement trim as defined in B4.
 - b) The boom shall be set horizontal when on centerline and then placed outboard with the weights fixed in the longitudinal position of the LCF (longitudinal center of flotation) from the stem. However, if this is not achievable, the longitudinal distance from the stem to the actual position of the weight shall be recorded as *LCFD*.
 - c) Heel angle without weights as a datum shall be recorded either with a manometer or an ORC-approved electronic inclinometer.
 - d) Weights shall be suspended on the end of the boom and resulting angle recorded again either with a manometer or an ORC-approved electronic inclinometer.
 - e) Same procedure in c) and d) shall be repeated on port and starboard sides, averaging the results
- E2.3 *PLM* shall be the length of the manometer from the center line of the fluid reservoir to the centerline of the gauge cylinder recorded in millimeters to one decimal place and shall not be less than 2000.0 mm.
- E2.4 *GSA* shall be the surface area of the manometer gauge in square millimeters.
- E2.5 *RSA* shall be the surface area of the fluid reservoir in square millimeters.
- E2.6 When an electronic inclinometer is used *PLM* shall be recorded as 9000, *GSA* and *RSA* as 1.0.

- E2.7 **WD** shall be:
- When the inclining test is performed with two poles: the horizontal distance from the point of attachment of the starboard weight to the point of attachment of the port weight with the weights distributed equally on the two pole ends. The weights shall be attached so that the weight distance is constant for all tests. The weight distance shall be of the order of $MB + 2.0 * SPL$.
 - When the inclining test is performed with boom: the average of the horizontal distances from the point of attachment of the weights on the boom on port and starboard sides to the boat's centerline.
- E2.8 **W1 ... W4** shall be the total weight suspended from the port pole for each reading of the manometer. They shall be of suitable magnitude to ensure that the largest **PD** is within:
- $\pm 0.01 * PL$ of $0.0275 * PL$ for yachts with $LOA > 24.0$ m
 - $\pm 0.01 * PL$ of $0.105 * PL$ for yachts with $LOA > 12.5$ m and $LOA \leq 24.0$ m
 - $\pm 0.01 * PL$ of $0.125 * PL$ for yachts with $LOA \leq 12.5$ m
- where $PL = PLM / (1 + GSA/RSA)$ and the intermediate values are approximately equally spread over the range. For inclining with the boom as in E2.2, PD limit values in a), b) and c) shall be divided by 2.
- E2.9 **PD1 ... PD4** shall be the deflections on the manometer gauge after each weight of the set has been moved, from the datum established in E2.1(d) or E2.2(c).
- E2.10 For boats of $LOA > 24.0$ m inclining data obtained from other measurements required by the classification companies or other maritime authorities may be used provided they are adjusted to the measurement trim and conditions as defined in B4.2. Use of such data shall be verified and approved by the ORC Chief Measurer.

E3 Canting Keel

- E3.1 The inclining test for a yacht equipped with a canting keel with symmetric maximum cant angles port and starboard shall be performed as follows:
- The inclining test shall be made with the canting keel on centerline according to E2.
 - The keel shall then be canted fully to starboard to the maximum angle or to the angle limited by the locking device above which canting keel shall not be canted while racing. The resulting list angle shall be recorded and the angle of the keel relative to the yacht's centerplane also recorded. These measurements shall be repeated and recorded with the keel canted fully to port.
- E3.2 **LIST** shall be the average of the port and starboard list angles to the nearest tenth of a degree. If the port and starboard list angles are not approximately equal, the yacht may be deemed not to comply with the provision above for symmetric cant angles.
- E3.3 **CANT** shall be the average of the port and starboard cant angles.

Part F - RIG

F1 General

- F1.1 Spars shall not be permanently bent. A spar that will straighten when stresses imposed by the rigging are removed does not constitute a permanently bent spar.
- F1.2 Masts shall not be rotating. Masts shall be structurally continuous (non-articulating) from the masthead to the step. Masts that are not stepped on the keel shall not be pivoted fore or aft while racing.
- F1.3 Boats shall be fitted with a forestay which may be adjustable if recorded as such according to F9.3. Forestay and shrouds shall be connected by conventional turnbuckles, toggles or link-plates. The mast may be steadied to balance an untensioned backstay only by use of a headsail halyard and its proper winch. A device for measuring forestay tension is permitted. Provided that it is incapable of adjusting the stay and has a possible movement of no more than 5 mm it shall be recorded as a fixed forestay.
- F1.4 The rig shall be measured according to the ERS except otherwise prescribed by the IMS, in which case IMS shall prevail.
- F1.5 The following amendments to the ERS shall apply:
- Mast datum point** shall be the intersection of the forward side of the mast, extended as necessary, and horizontal plane at the at top point of the station abreast the mast.
 - Rigging point** shall be the attachment of the forestay to the mast structure, or the intersection of the center line of the forestay with the foreside of the mast where the point of attachment is internal.
 - Upper point** of the mast shall be the lowest point of the **upper limit mark** at the aft edge of the mast or top of the highest sheave used for the main halyard.
 - Outer point** of the boom shall be the point on the boom's **outer limit mark** at the upper edge, nearest the fore end of the boom or the aftermost position to which the sail can possibly extend.
 - Limit Marks** shall be permanently marked. The **Limit mark width** shall be not less than 25mm. 'Permanent' shall mean unable to be removed and repositioned without destroying them.

F2 Mainsail Hoist

- F2.1 *P* shall be the **mainsail luff mast distance**.
- F2.2 If a sliding gooseneck is used the **lower limit mark** shall be placed at the height below which the foot shall not be while *racing*.

F3 Mast Heights

- F3.1 *IG* shall be the **forestay height**.
- F3.2 *ISP* shall be the highest of:
- the **spinnaker hoist height**, or
 - the intersection of the **spar** and the lower edge of the **halyard** of **headsail set flying**, when at 90° to the **spar**, each extended as necessary.
- If there is any lower spinnaker halyard or the halyard of the headsail **set flying** these shall be recorded as *ISP1*, *ISP2*, etc ... from the top down."
- F3.3 *SPS* shall be the vertical distance from the **mast datum point** to the point on the mast intersected by the centerline of the spinnaker pole when set at the highest point on its track or to the lowest point of a painted measurement mark on the mast in which case the pole shall not be attached to the mast above that point while *racing*.
- F3.4 *BAS* shall be the highest vertical distance between **mast datum point** and **lower point** on the mast.

F4 Mast Spar Dimensions

- F4.1 **MDT1** shall be the maximum **transverse mast spar cross section** above $0.5 * P$ from the **lower point**.
- F4.2 **MDL1** shall be the maximum **fore-and-aft mast spar cross section** above $0.5 * P$ from the **lower point**.
- F4.3 **MDT2** shall be the minimum **transverse mast spar cross section** below the **upper point**.
- F4.4 **MDL2** shall be the minimum **fore-and-aft mast spar cross section** below the **upper point**.
- F4.5 **TL** shall be the vertical distance from the highest point at which **MDT1** or **MDL1** occurs, whichever is lower, to the **upper point**.
- F4.6 **MW** shall be the minimum **fore-and-aft mast spar cross section** below the **rigging point** and above the lowest spreader.
- F4.7 **GO** shall be the horizontal distance from the **rigging point** to the after side of the mast or vertical projection of the after side of the mast.
- F4.8 **GOA** shall be the distance between the **upper point** on the aft face of the mast to the center of attachment point of the upper end of the backstay.

F5 Boom Spar Dimensions

- F5.1 **E** shall be the **outer point distance**.
- F5.2 **BD** shall be the maximum **vertical boom spar cross section**.
- F5.3 **BAL** shall be the distance from the **outer point** to the **limit mark** denoting the limit on the boom beyond which no lead for the sheeting of headsail or spinnaker shall be attached. In the absence of such a band **BAL** shall be measured to the boom end.
- F5.4 **BWT** shall be the **boom weight**.

F6 Rigging Measurements

- F6.1 **J** shall be the **foretriangle base**. Where there is the capacity for the mast to be moved at the deck, **J** shall be measured with the mast at the aftermost limit of adjustment unless a 1 in. (25mm) contrasting measurement band is provided. In this case **J** shall be measured to the aft edge of the band and the forward face of the mast shall not move aft of this point.
- F6.2 **SFJ** shall be the horizontal distance from the forward end of **J** to the forward end of **LOA** (negative if the forward end of **J** is ahead of the forward end of **LOA**).
- F6.3 **CPW** shall be the distance between the centers of the bearing points of the chainplates for the upper shrouds of the mainmast.
- F6.4 **CPD** shall be the distance between the center of the bearing point of the chainplate for the upper shrouds to the mainmast centerline.
- F6.5 **FSD** shall be the maximum dimension of a luff groove device measured at right angles to the longitudinal axis. **FSD** shall be half the value of **FSP** as measured before 01/01/2020.

F7 Spinnaker Pole and Bowsprit and Whisker Pole

- F7.1 **SPL** shall be the horizontal distance from the forward face of the mast spar, ignoring any fittings and tracks, measured on or near the centerline of the boat, to the extremity of the spinnaker pole.
- F7.2 **TPS** shall be the greatest horizontal distance from the forward face of the mast spar, ignoring any fittings and tracks at its lowest point above the deck or coach roof to the foremost of:
- the point of attachment of the tacking point of any spinnaker or any headsail **set flying**, or
 - the extremity of the **bowsprit**.

If there is any other point of attachment of the tacking point of a headsail **set flying**, between the bowsprit outer point and the mast, respective distances from these points to the mast shall be recorded as ***TPS1***, ***TPS2***, etc ... from the foremost point to the mast.

F7.3 If bowsprit can be moved sideways from the centerline this shall be recorded as “YES” and if not as “NO”.

F7.4 ***WPL*** shall be the horizontal distance from the forward face of the mast spar, ignoring any fittings and tracks, measured on or near the centerline of the boat, to the extremity of the **whisker pole** that may be set on leeward to set a headsail.

F8 Rig Weight and Center of Gravity

F8.1 ***MWT*** shall be the weight of the mast together with standing rigging with the components dry and the spars fitted only with components with which the yacht will use whilst *racing* as specified below:

a) The mast shall be completely rigged with standing rigging, backstays, running backstays, spreaders, jumpers, lights, antennae, instrument displays and their mounting brackets, wiring and transducers, luff groove device and all other permanently attached fittings, including those turnbuckles which are not permitted to be adjusted while *racing*.

b) Excluded for measurement shall be running rigging (except backstays and running backstays as required in F8.1(a) above), checkstays, rigging adjusters of any type (hydraulic or otherwise) and any associated blocks and tackle, boom vang and reefing tackle. Halyard messengers of not more than 4mm diameter and weighing not more than 15 grams per meter and only sufficient for convenient re-leading may be used to replace internal portions of running rigging.

c) All wiring, messengers and standing rigging shall be in their proper attached positions, and any slack stretched down and secured along the length of the mast with light material, such as lanyards or tape, with any tails hanging free at the butt.

d) Headboard, luff slides, spinnaker pole cars and any other adjustable devices shall be at their lowest limit of travel.

F8.2 ***MCG*** shall be the distance from the vertical center of gravity of the mast when fitted out for weighing as defined in F8.1 to the **lower point** on the mast.

F8.3 As appropriate to the size of the mast, the values for ***MWT*** and ***MCG*** may be found either by measurement at the single point of the center of gravity of the mast and rigging or by measurement of tip and butt weights separately, followed by calculation of these values to be recorded.

F9 Other Rig Measurements

F9.1 ***Jumper Struts***. If the mainmast incorporates jumper struts, this shall be recorded as “YES” and if not as “NO”.

F9.2 ***Inner stay***. If there is an inner stay, the tension of which may be adjusted, this shall be recorded as “ADJUSTABLE”. If inner stay tension can not be adjusted, this shall be recorded as “FIXED”.

F9.3 ***Forestay tension***.

a) If the uppermost backstay is adjustable, this shall be recorded as “ADJUSTABLE AFT”.

b) If the forestay is adjustable and backstay is fixed, this shall be recorded as “ADJUSTABLE FORWARD”.

c) If the forestay is adjustable and backstay is adjustable, this shall be recorded as “ADJUSTABLE AFT & FORWARD”.

d) If neither the uppermost backstay nor forestay itself is adjustable, this shall be recorded as “FIXED”.

F9.4 ***Number of spreaders*** shall be recorded.

- F9.5 **Number of runners.** Running backstays and checkstays (according to the ERS) shall be recorded as “runners”. A backstay that enters the mast below the upper limit mark, but it is attached in the internal structure above the upper limit mark, shall not be counted as a “runner”. The number of pairs shall be recorded. Any secondary runner tension adjuster, fitted to the mast within $0.1 * IG$ from the upper attachment point of the runners, shall not be counted as another pair of runners.
- F9.6 **Taper Hollows.** If the mast taper has hollows, this shall be recorded as “YES” and if not as “NO”.
- F9.7 If **MWT** and **MCG** are not measured following shall be recorded:
- Carbon mast.** If the mast is made of carbon, this shall be recorded as “YES and if not as “NO”.
 - Fiber rigging.** If any part of the standing rigging is made of any fiber, this shall be recorded as “YES” and if not as “NO”.
 - Mainsail furler:** If there is a mainsail furler in the mast, this shall be recorded as “YES” and if not as “NO”.
- F9.8 If there is a headsail furler on a fixed forestay used in association with only one headsail, which has **HLP** greater than 110% of **J**, this shall be recorded as “YES” and if not as “NO”.
- F9.9 If the standing rigging has any non-circular sections, this shall be recorded as “YES” and if not as “NO”.
- F9.10 If there is a backstay, this shall be recorded as “YES” and if not as “NO”.
- F9.11 If non-manual power can be used for adjusting running rigging or spars, this shall be recorded as follows:
- SHEETS:** when non-manual power is used for adjusting clew of a sail or a boom
 - RIG:** when non-manual power is used for adjusting backstay, vang or outhaul
 - YES:** what include a) and b) above used together
 - NO:** when there is no non-manual power used.
- F10 Mizzen Rig Measurements**
- F10.1 **PY, MDT1Y, MDL1Y, MDT2Y, MDL2Y, TLY, BASY, EY, BDY, BALY** shall be taken as corresponding measurements defined in F2 – F5.
- F10.2 **IY** shall be the vertical distance from the **mast datum point** to the higher of:
- the center of the highest eyebolt or eye used for a mizzen staysail; or
 - the intersection of the foreside of the mizzen mast with the highest strop used for the halyard of a mizzen staysail.
- F10.3 **EB** shall be the distance at deck level between the after side of the mainmast to the foreside of the mizzen mast.

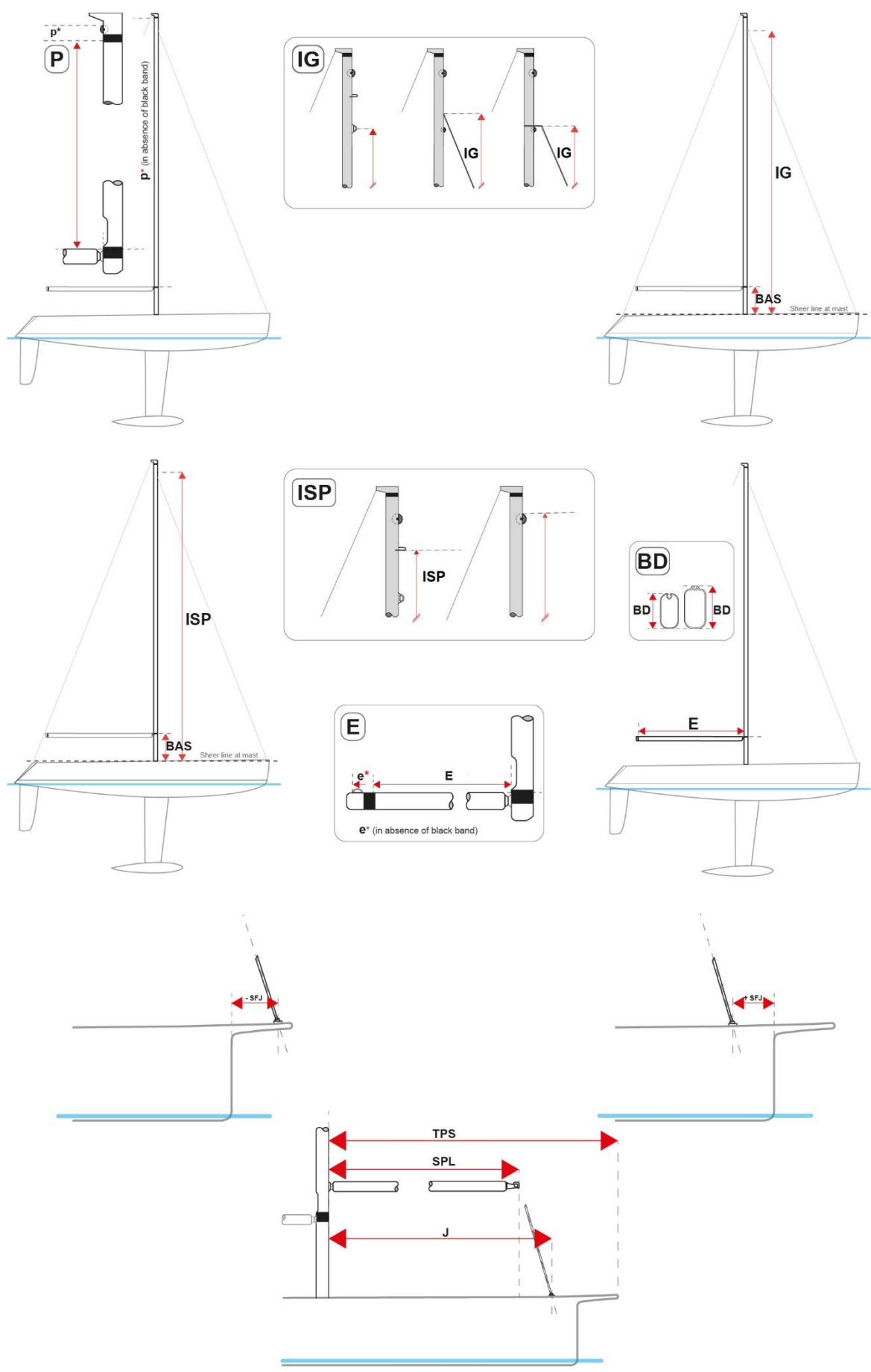

Diagrams for illustration only

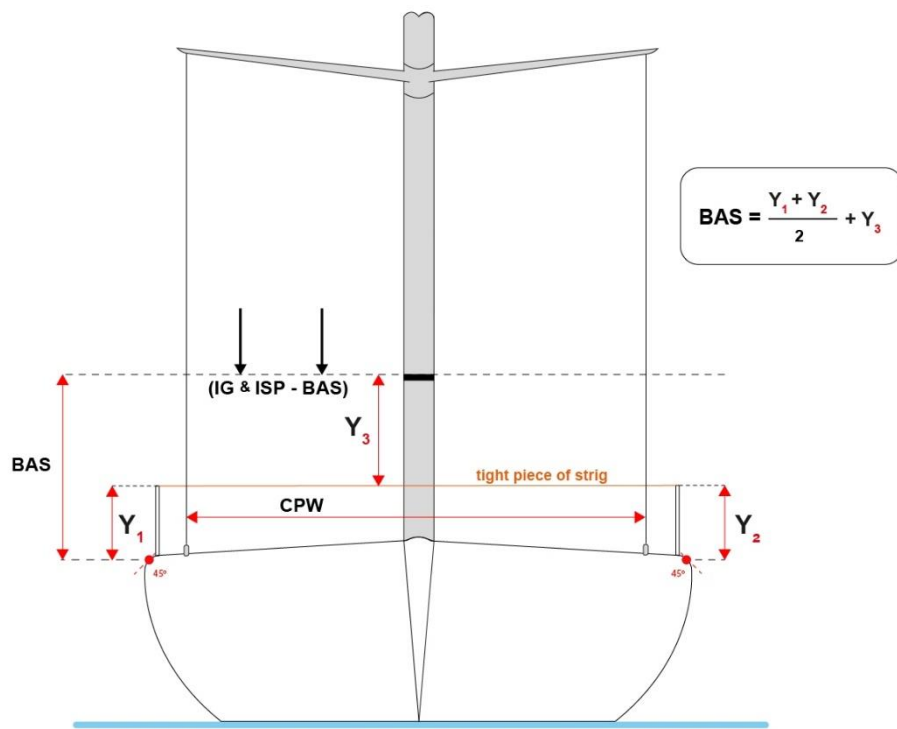
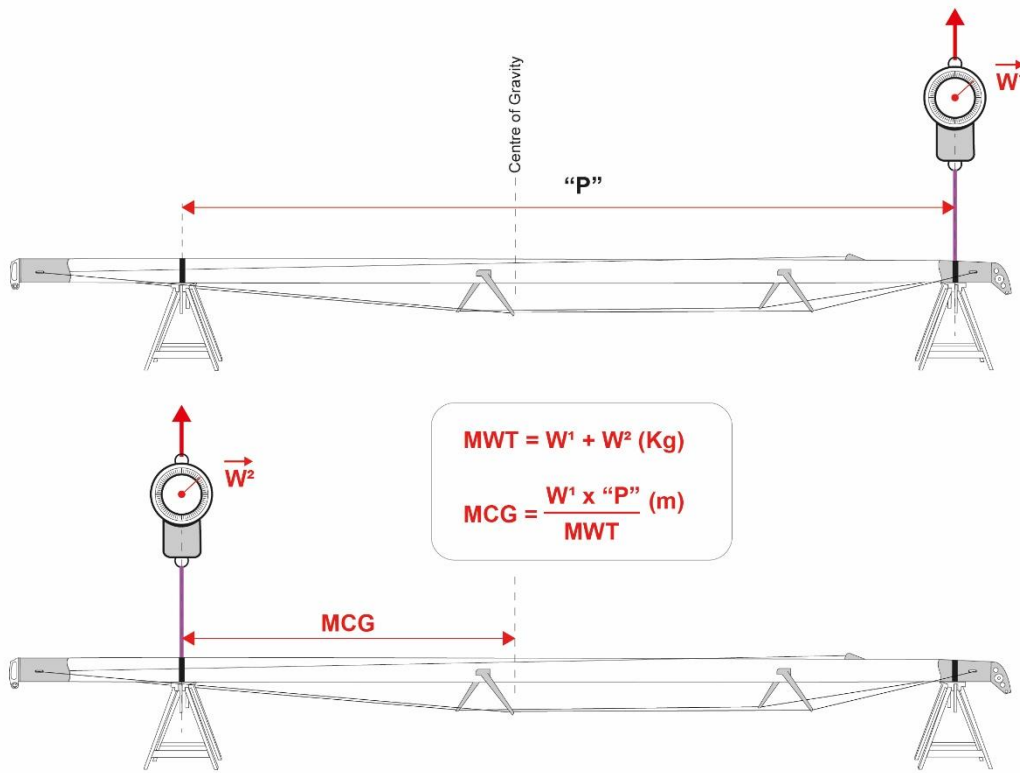

Diagrams for illustration only

Part G - SAILS

G1 General

- G1.1 A sail shall not be constructed in such a manner that any portion may be completely detached.
- G1.2 No device other than a normal leech line shall be used to adjust the curvature of any batten.
- G1.3 Sails shall be measured according to the ERS except otherwise prescribed by the IMS, in which case IMS shall prevail.
- G1.4 If a **seven-eighths leech point** cannot be found on the **leech**, the **aft head point** shall be taken as the **seven-eighths leech point**.
- G1.5 If mainsail and all headsails are made of woven polyester, this shall be recorded as “YES” and if not as “NO”.
- G1.6 ERS H5.4 does not apply.
- G1.7 ERS definition of **Set Flying** is changed to: “A **sail** set with no **sail edge** attached to the **forestay**.”

G2 Mainsail

- G2.1 The following measurements shall be taken:

MHB shall be the **top width** except as defined in G2.2

MUW shall be the **seven-eighths width**.

MTW shall be the **three-quarter width**.

MHW shall be the **half width**.

MQW shall be the **quarter width**.

Measurements of **MUW**, **MTW**, **MHW** and **MQW** shall be equal or greater than the closest measurement above it.

- G2.2 If the centerline of a batten pocket is situated above the **seven-eighths leech point**, a straight line shall be taken through **seven-eighths leech point** and the centerline of the lowest batten on the **leech** situated above this point. The intersection of that straight line and the line through the **head point** at 90° to the **luff** shall be taken as the point from which **MHB** shall be measured to the **head point**.

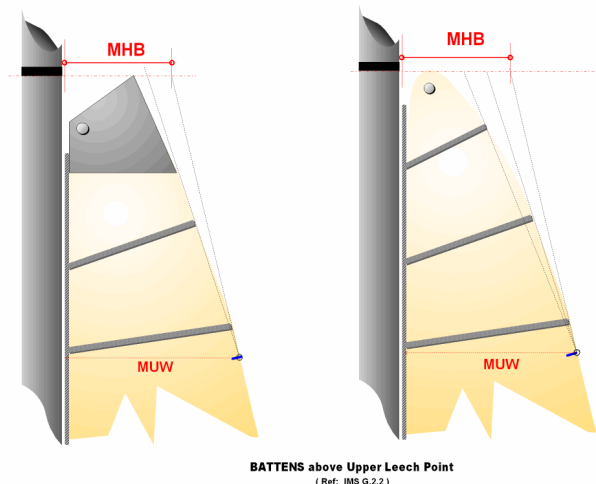

Diagram for illustration only

G3 Mizzen

MHBY, **MQWY**, **MHWY**, **MTWY**, **MUWY** shall be taken as corresponding measurements defined in G2.

G4 Headsail

G4.1 A headsail is a sail set forward of the mast, or of the foremost mast if there is more than one mast, and not qualifying as a spinnaker according to G6.1. The following measurements shall be taken:

HHB shall be the **top width**.

HUW shall be the **seven-eighths width**.

HTW shall be the **three-quarter width**.

HHW shall be the **half width**.

HQW shall be the **quarter width**.

HLU shall be the **luff length**.

HLP shall be the **luff perpendicular**.

The measurements can be reduced to the last two items for headsail measurements before 01/01/2009 or when the leech has a clear hollow and the headsail is not the largest in the sails inventory.

If there are battens on the headsails, this shall be recorded as “YES” and if not as “NO”. If a headsail is **set flying**, this shall be recorded as one of the following:

- a) YES: Headsail is **set flying** tacked in front of the forestay.
- b) INNER: Headsail is **set flying** tacked between the forestay (included) and the mast
- c) NO: Headsail is set on the forestay.

An appropriate combination of hoists (***ISP***) and tack points (***TPS***) where headsails **set flying** are set shall be recorded”.

G4.2 Any device or sail construction used to artificially shorten a **luff** shall be removed for the ***HLU*** measurement.

G4.3 The distance between **half foot point** and **half luff point** on the headsail shall be not greater than 55% of ***HLU***.

G5 Mizzen Staysail

Mizzen staysails shall be three-cornered. The following measurements shall be taken:

YSHF shall be the shortest distance that can be measured from **head** to **foot**.

YSHW shall be the **half width**.

YSFL shall be the **foot length**.

G6 Spinnakers

G6.1 The **half width** of any spinnaker shall be 75% or more of the **foot length**.

G6.2 The symmetric spinnaker shall be symmetric in shape, material and cut, about a line joining the **head** to the center of the **foot**. The symmetric spinnaker shall not have adjustable leech lines. Any spinnaker not qualifying as symmetric shall be considered as asymmetric.

G6.3 Battens are not permitted on any spinnaker.

G6.4 The following measurements shall be taken on symmetric spinnaker:

SLU shall be the **luff length**.

SLE shall be the **leech length**.

SHW shall be the **half width**.

SFL shall be the **foot length**.

G6.5 The following measurements shall be taken on asymmetric spinnaker:

SLU shall be the **luff length**.

SLE shall be the **leech length**.

SHW shall be the **half width**.

SFL shall be the **foot length**.

G7 Quadrilateral sails and sails set on the wishbone boom

G7.1 Quadrilateral sails with the **sprit** or **gaff** set or sails set with the **wishbone boom** shall be measured according to the ERS – Subsection B

G7.2 The following measurements shall be taken:

QLE shall be the **leech length**.

QHL shall be the **head length**.

QFL shall be the **foot length**.

QCD shall be the **clew diagonal**.

QLM shall be the distance between the **half leech point** and the **throat point**.

G8 Sail Measurement Stamp

All sails shall be available for measurement. The measurer shall mark the sails complying with the IMS with an ORC-approved stamp, enter the measurements found, date and sign them. The stamp shall be placed at the **head** of the sail, except for the sails where the **head** may not easily be inspected (like furling sails) in which case, the stamp shall be placed at the **clew**. The stamp shall be issued by the Rating Authority for which a 3-letters national code shall be displayed in the rightmost column of the first row, as shown below

ORC	Measurer : n° :	MNA
dd / mm / yy	Signed :	

MAINSAIL

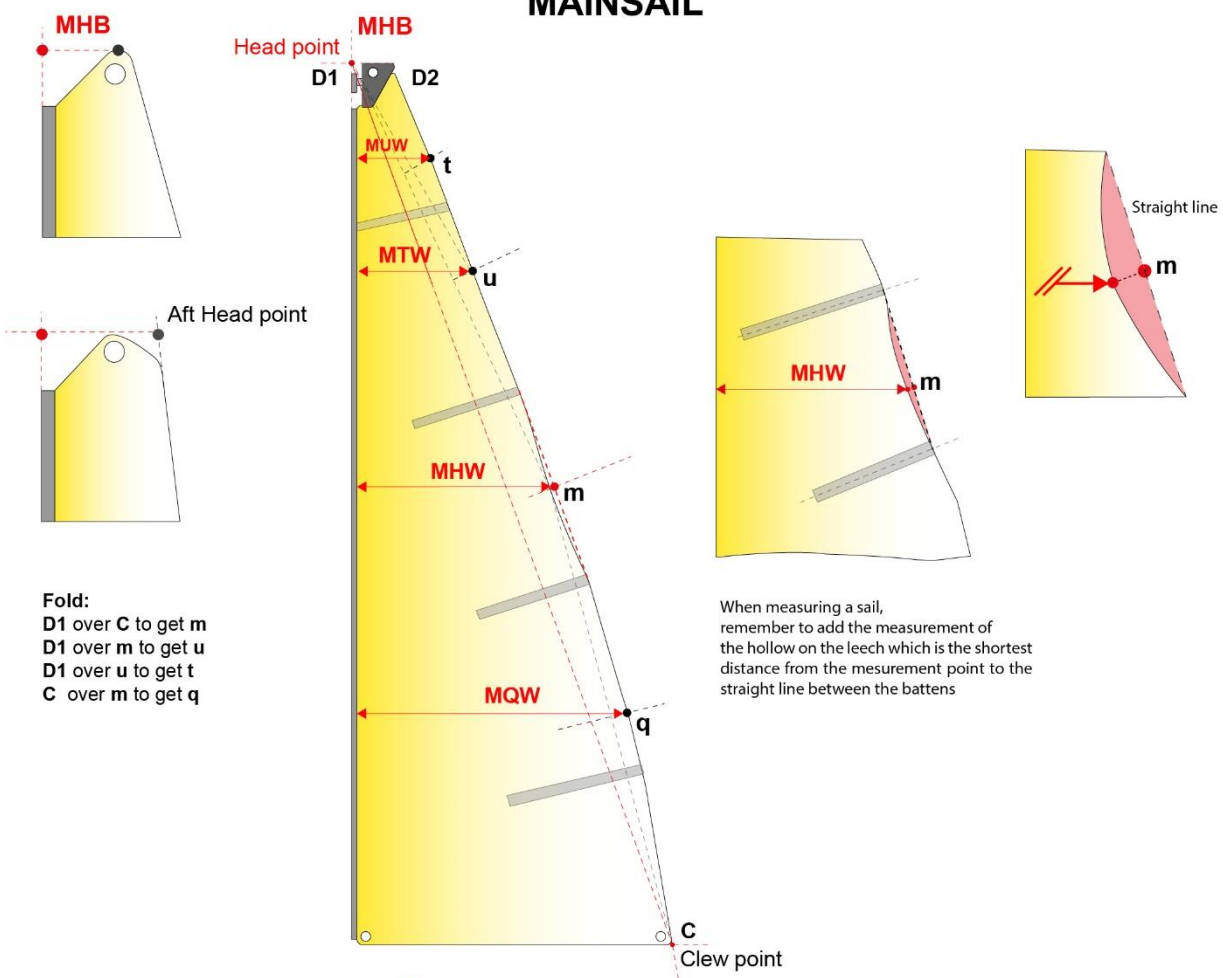

HEADSAIL

(Set on a stay attached forward of the mast)

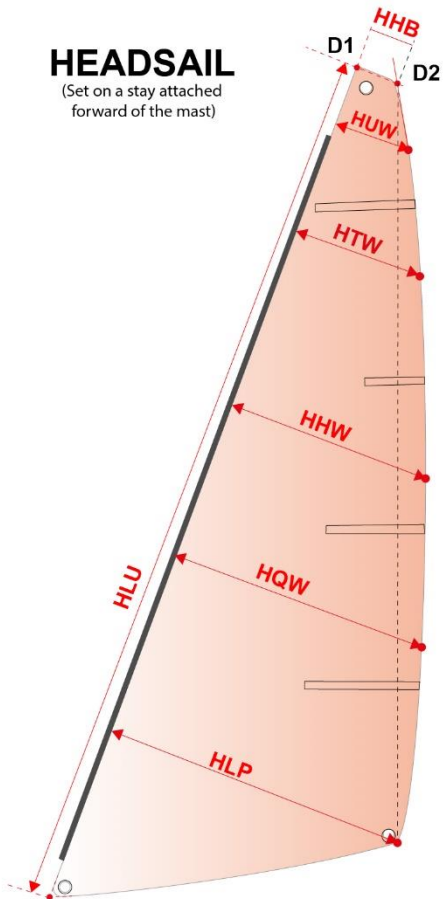

HEADSAIL SET FLYING

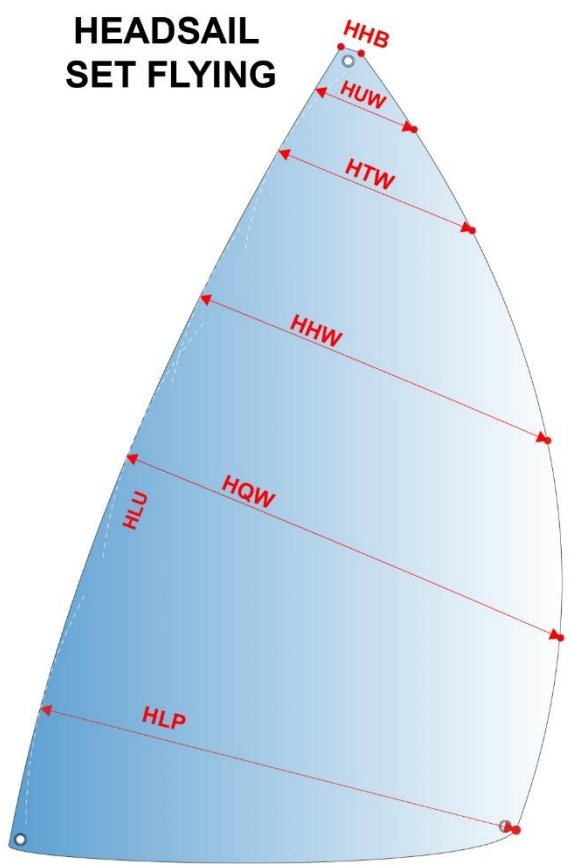

Diagrams for illustration only

SPINNAKERS

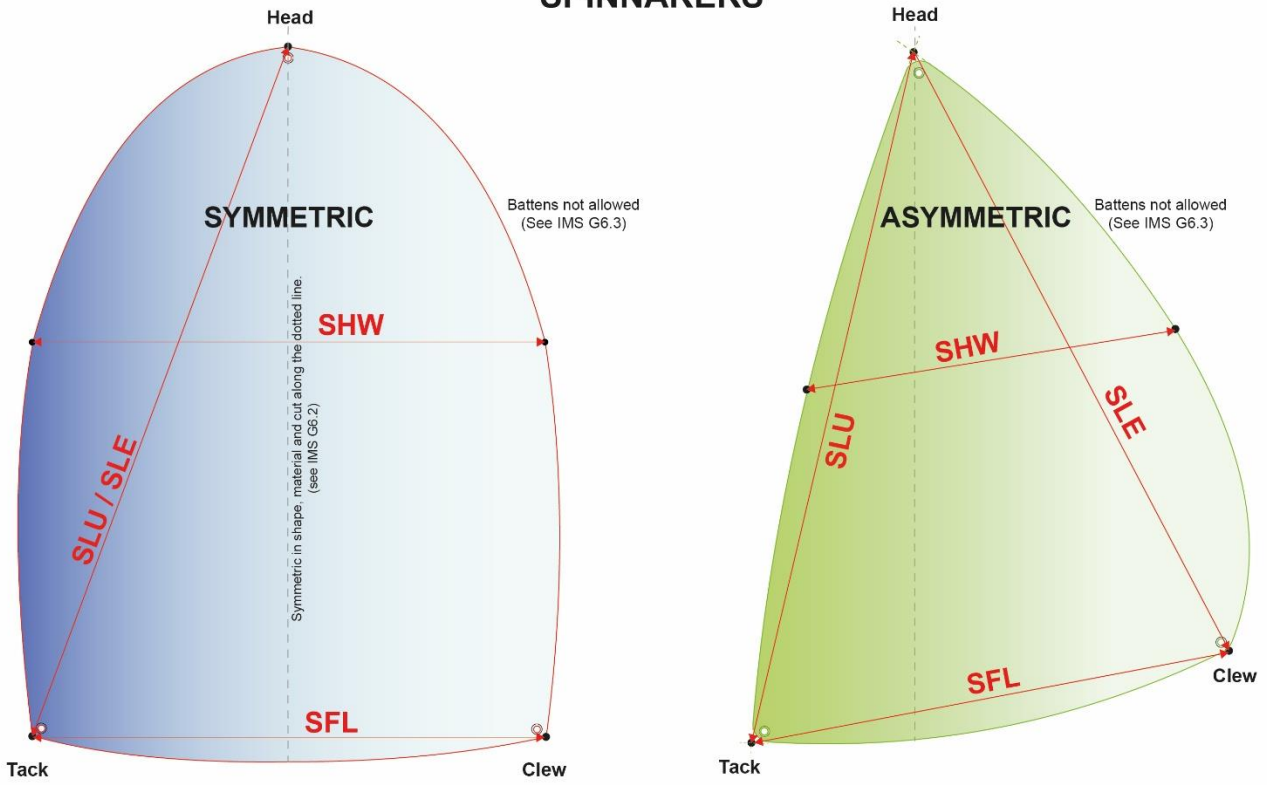

G6.1 half width of any spinnaker shall be 75% or more of the foot length. If not, the sail shall be measured as a headsail

QUADRILATERAL SAIL

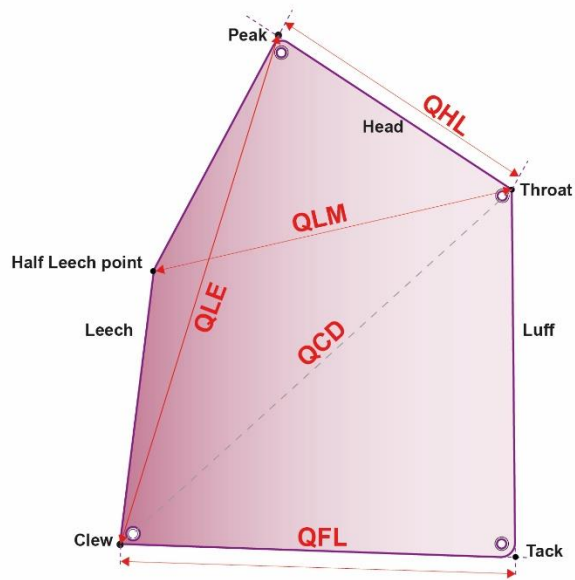

Diagrams for illustration only

Appendix 1 – CRUISER/RACER REGULATIONS

PART 1 - GENERAL

Introduction

The purpose of these regulations is to define requirements for categorizing boats as Cruiser/Racers controlling the cost, promoting safety and crew comfort. Cruiser/Racer yachts shall be those designed for cruising and longer stay on a boat and the minimum requirements are intended to guarantee as far as possible that boat follow the basic philosophy which include:

- The purpose of the yacht shall be in the first instance cruising.
- Accommodation layout and outfit shall be at least comparable to the standards of series production models which would find a broad market as cruising yachts.
- Sacrifice of layout and accommodation to features which are primarily suited to the racing character of a yacht shall be suppressed.
- The yacht without modification is fully suitable and actually used for cruising.

101 Cruiser/Racer Category

1. Boats complying with these regulations shall be categorized as Cruiser/Racers and all IMS and ORC rules and regulations as well as VPP calculations using C/R category shall apply to these boats.
2. Boats not complying with these regulations shall be categorized in Performance category.
3. Boats measured before 01/01/2010 shall comply with accommodation regulations applicable at the time of measurement where former Cruiser/Racer division will be grandfathered as Cruiser/Racer category and former Racing Division and None will be grandfathered as Performance category.
4. Any division of fleets, whether only for scoring purposes or to actually separate fleets on the race course, is at the discretion of National Authorities or local event organizers. However, when fleet is divided Cruiser/Racer category boats may on their own choice join the Performance category.

102 Fundamental Requirements and Definitions.

1. All systems relating to living, eating, sleeping, and stowage specified in these regulations shall be arranged in a manner suitable for cruising use and shall operate so as to provide the service function normally associated with the system. Items shall be presented as they are intended to be used. For example, any item intended for use as a berth shall be in place and its function declared at the time of inspection.
2. Designations such as table, berth, sink, stove, refrigerator, and so forth are intended to define the full utility of conventional equipment and whatever weight is customarily associated with it.
3. Designations such as locker, bin and drawer, specify rigid construction and full practicality for convenient and safe segregated stowage usable and accessible under offshore conditions. The contents of all compartments shall be fully secured by doors or other suitable devices.
4. “Permanently Installed” means items are built in and may not be removed from their permanently installed position for measurement or during racing.

PART 2 – ACCOMMODATION REQUIREMENTS

201 Accommodation Areas. The interior of the yacht should include: living area with table and settee, sleeping area(s), galley area, navigation area and a separate enclosed compartment for toilet/wash basin, accessible through a rigid door. Living areas and sleeping areas should be separated by means of rigid bulkheads or partitions.

202 Accommodation Length (AL) shall be the lesser of *LOA* or $3.25 * MB$, calculated to the nearest 0.1m.

203 A Cabin Sole shall extend fore and aft over a length which provides convenient access to lockers, berths, galley, head, navigation area and other components making up the yacht’s interior.

204 Headroom (HR) measured from cabin sole to the ceilings shall be not less than

- For yachts with an AL of 8.5m or less, HR = 1.40 m*
- For yachts with an AL between 8.6m and 14.4m: HR = 1.5 + 0.1656 * (AL - 8.5)^0.5 (metres)*
- For yachts with an AL of 14.5m or more, HR = 1.90 m*

205 Living Area. A living area (cabin) shall consist of space containing a table and settees.

1. **Table** should be permanently installed, of substantial construction and arranged with convenient seating, fixed to the cabin sole or hinged from a bulkhead to facilitate stowage.

$$\text{Required table area} = 0.11 * \text{Min. Number of Berths (m}^2\text{)}$$

2. **Settees** are required sufficient to allow a number of crew equivalent to the number of berths to sit around the table.

206 Sleeping Area shall consist of a space containing berths and adequate facilities for personal gear stowage.

1. **Berths.** Each single berth should be at least 1.9m in length and at some point at least 0.6m in width. A double berth shall be at least twice the width of a single berth. The ends of berths may taper as required by the hull shape. Mattresses are to be fitted to all such berths.

<u>Accommodation Length</u>	<u>Min. Number of Berths</u>
AL ≤ 7,9	2
8,0 ≤ AL ≤ 8,9	3
9,0 ≤ AL ≤ 10,6	4
10,7 ≤ AL ≤ 12,7	5
12,8 ≤ AL ≤ 14,9	6
15,0 ≤ AL ≤ 17,0	7
17,1 ≤ AL ≤ 19,1	8
19,2 ≤ AL ≤ 21,2	9
21,3 ≤ AL ≤ 23,4	10
AL ≥ 23,5	11

2. **Personal Gear Stowage** shall be provided in the form of built-in lockers with doors, bins with hatches or drawers.

$$\text{Required volume} = 0.04 * \text{Min. Number of Berths (m}^3\text{)}$$

207 Galley Area:

A galley area is not permitted in a space counted as a Sleeping Area and shall include:

1. **Stoves:** A gimballed stove fitted with high retaining rails to permit safe operation underway.
2. **Sinks:** Permanently installed and fitted with pump/tap and drainage system.
3. **Galley Gear Stowage:** Should be provided in rigid lockers, bins or compartments.
4. **Food Stowage:** Stowage for food should be provided in rigid lockers, bins or compartments.

$$\text{Required volume} = 0.06 * \text{Min. Number of Berths (m}^3\text{)}$$

- 208** 1. **Toilet** Marine type permanently installed and operable in compliance with local regulations.
2. **Wash Basin:** Near the toilet, fitted with pump/tap and drainage system which permits use underway.
- 209** **Navigation Area** shall include flat area suitable for chart work. The area should be built with storage for charts, navigational instruments, books, etc. In smaller yachts, counter tops, cabin tables or portable chart boards.
- 210** **Hanging Locker(s)** shall be of sufficient dimension to permit hanging garments vertically.
- 211** **Fresh Water Capacity:** For yachts with an AL of 8.5m and greater fresh water pumps shall be installed at the sink and wash basin and fresh water shall be contained in permanently installed tankage either of rigid construction or of the bladder type.
*Min. fresh water capacity in litres = (5*AL-30) * Min. Number of Berths*
- 212** **Fuel Capacity:** Yachts with inboard engines shall be directly supplied from permanently installed fuel tankage.
For AL of 8.5m or less the required capacity for diesel fuel is 20 litres.
*For AL of 8.6m or more the required capacity for diesel fuel = 20*AL -150 (litres).*
*Fuel capacity for gasoline = 1.25 * fuel capacity for diesel.*
- 213** **Cockpit**
For cruising amenity, the cockpit should feature fixed seating, seatbacks and coamings. The length of seating should accommodate crew numbers at least equal to the required number of berths.

INDEX OF SYMBOLS

AL	Accommodation Length	202	MDT2Y	Min. Transverse Mast Mizzen	F10.1
APB	Aperture Bottom Width	D4.16	MHB	Mainsail Top Width	G2.1
APH	Aperture Height	D4.15	MHBY	Mizzen Top Width	G3
APT	Aperture Top Width	D4.16	MHW	Mainsail 1/2 Width	G2.1
BAL	Boom After Sheeting Limit	F5.3	MHWY	Mizzen 1/2 Width	G3
BALY	Boom After Sheeting Limit Mizzen	F10.1	MQW	Mainsail 1/4 Width	G2.1
BAS	Boom Above Sheerline	F3.4	MQWY	Mizzen 1/4 Width	G3
BASY	Boom Above Sheerline Mizzen	F10.1	MTW	Mainsail 3/4 Width	G2.1
BD	Boom Diameter	F5.2	MTWY	Mizzen 3/4 Width	G3
BDY	Boom Diameter Mizzen	F10.1	MUW	Mainsail Upper Width	G2.1
BWT	Boom Weight	F5.4	MUWY	Mizzen Upper Width	G3
CANT	Average Cant Angle	E3.3	MW	Mast Width	F4.6
CPD	Chainplate Diagonal	F6.4	MWT	Mast Weight	F8.1
CPW	Chainplate Width	F6.3	P	Mainsail Luff Mast Distance	F2.1
DMT	Deepest Point of Keel	B6.6	PBW	Propeller Blade Width	D4.4
DSPW	Displacement as Weighed	B6.11	PD1-4	Pendulum Deflections	E2.9
E	Mainsail Foot	F5.1	PHD	Propeller Hub Diameter	D4.2
EB	Distance Between Masts	F10.3	PHL	Propeller Hub Length	D4.3
EDL	Strut Drive Length	D4.8	PLM	Length of Manometer	E2.3
ESL	Exposed Shaft Length	D4.7	PRD	Propeller Diameter	D4.1
EY	Mizzen Foot	F10.1	PSA	Propeller Shaft Angle	D4.5
FAM	Freeboard Aft Measured	B5.4	PSD	Propeller Shaft Diameter	D4.6
FBI	Freeboard at Mast Station	B6.8	PY	Mizzen Hoist	F10.1
FFM	Freeboard Forward Measured	B5.3	QCD	Quadrilateral Clew Diagonal	G7.2
FMD	Freeboard at Maximum Draft Station	B6.7	QFL	Quadrilateral Sail Foot Length	G7.2
FO	Forward Overhang	B6.10	QLE	Quadrilateral Sail Leech Length	G7.2
FSD	Forestay Diameter	F6.5	QLH	Quadrilateral Sail Head Length	G7.2
FSP	Forestay Perpendicular	F6.5	QLM	Quadrilateral Leech Median	G7.2
GO	Forestay Outtrigger	F4.7	SAFP	Stem to Aft Freeboard Station	B5.2
GOA	Backstay Gantry	F4.8	SFL	Spinnaker Foot	G6.4, 6.5
GSA	Gauge Surface Area	E2.4	SFFP	Stem to Forward Freeboard Station	B5.1
HHB	Headsail Top Width	G4.1	SFJ	Stem to Forward End of J	F6.2
HHW	Headsail 1/2 Width	G4.1	SG	Specific Gravity	B5.5
HLU	Headsail Luff	G4.1	SLE	Spinnaker Leech	G6.4, 6.5
HLP	Headsail Perpendicular	G4.1	SLU	Spinnaker Luff	G6.4, 6.5
HQW	Headsail 1/4 Width	G4.1	SMB	Stem to Maximum Beam Station	B6.4
HTW	Headsail 3/4 Width	G4.1	SDM	Stem to Maximum Draft Station	B6.5
HUW	Headsail Upper Width	G4.1	SHW	Spinnaker Half Width	G6.4, 6.5
IG	Forestay Height	F3.1	SPL	Spinnaker Pole Length	F7.1
IH	Interior Height	202, 302	SPS	Height of Spinnaker Pole Stop	F3.3
ISP	Height of Spinnaker Hoist	F3.2	ST1-5	Propeller Strut Dimensions	D4.9-13
IY	Height of Mizzen Mast	F10.2	TL	Taper Length	F4.5
J	Foretriangle Base	F6.1	TLY	Taper Length Mizzen	F10.1
LCFD	Boom Position at Inclining	E2.2(b)	TPS	Tacking Point of Spinnaker or Headsail Set Flying	F7.2
LIST	Average List Angle	E3.2	W1-4	Inclining Weights	E2.8
LOA	Length Overall	B6.2	WBV	Water Ballast Volume	B4.4
MB	Maximum Beam	B6.3	WCBA	Centerboard Weight	C2.4
MCG	Mast Centre of Gravity	F8.2	WD	Weight Distance	E2.7
MDL1	Max. Fore-and-Aft Mast	F4.2	WPL	Whisker Pole Length	F7.4
MDL1Y	Max. Fore-and-Aft Mast Mizzen	F10.1	Y	Transom Height	B6.9
MDL2	Min. Fore-and-Aft Mast	F4.4	YSFL	Mizzen Staysail Foot Length	G5
MDL2Y	Min. Fore-and-Aft Mast Mizzen	F10.1	YSHF	Mizzen Staysail Head to Foot	G5
MDT1	Max. Transverse Mast	F4.1	YSHW	Mizzen Staysail Half Width	G5
MDT1Y	Max. Transverse Mast Mizzen	F10.1			
MDT2	Min. Transverse Mast	F4.3			

Sail measurements abbreviations before and after 01/01/2016

	Dimension	Old Abbreviation	New Abbreviation
Mainsail	Mainsail Quarter Width	MGL	MQW
	Mainsail Half Width	MGM	MHW
	Mainsail Three Quarter Width	MGU	MTW
	Mainsail Upper Width	MGT	MUW
	Mainsail Top Width	HB	MHB
Headsail	Headsail Luff Length	JL	HLU
	Headsail Quarter Width	JGL	HQW
	Headsail Half Width	JGM	HHW
	Headsail Three Quarter Width	JGU	HTW
	Headsail Upper Width	JGT	HUW
	Headsail Top Width	JH	HHB
	Headsail Luff Perpendicular	LPG	HLP
Spinnaker	Spinnaker Luff Length	SL (SLU)	SLU
	Spinnaker Leech Length	SL (SLE)	SLE
	Spinnaker Foot Length	SF (ASF)	SFL
	Spinnaker Half Width	SMG (AMG)	SHW
Mizzen	Mizzen Quarter Width	MGLY	MQWY
	Mizzen Half Width	MGMY	MHWY
	Mizzen Three Quarter Width	MGUY	MTWY
	Mizzen Upper Width	MGTY	MUWY
	Mizzen Top Width	HBY	MHBY
Mizzen staysail	Mizzen Staysail Head to Foot	YSD	YSHF
	Mizzen Staysail Half Width	YSMG	YSHW
	Mizzen Staysail Foot Length	YSF	YSFL